

## 5.5-16GHz Variable Gain Amplifier

*Preliminary*

### GaAs Monolithic Microwave IC in SMD package

#### Description

The CHA4664-QGG is a variable gain broadband three-stage monolithic amplifier.

It is designed for a wide range of applications, typically commercial communication systems.

The circuit is manufactured with a Power pHEMT process, 0.15 $\mu$ m gate length, via holes through the substrate and air bridges.

It is available in lead-free SMD package.

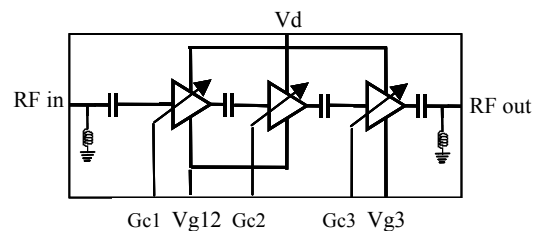
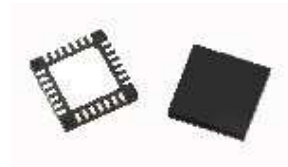

#### Main Features

- Broadband performance 5.5-16GHz
- 23dB Gain @ 7dB Noise Figure
- 23dB Gain control range
- 28dBm Output IP3 @ gain max
- 23dBm Output Power @ 1dB compression
- DC power consumption, 220mA @ 4.5V
- 28LQFN5x5
- ESD protected (see page 14)

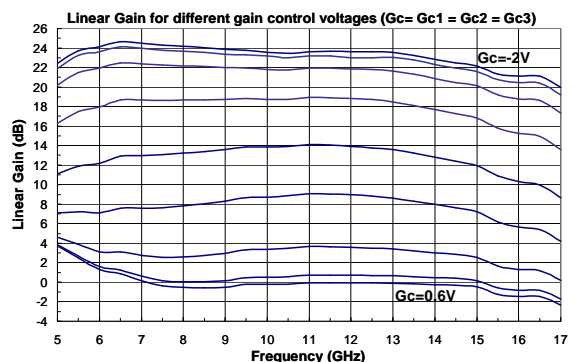

Typical On board measurements

#### Main Characteristics

Tamb. = 25°C, Vd = 4.5V

Symbol	Parameter	Min	Typ	Max	Unit
Fop	Operating frequency range	5.5		16	GHz
G	Small signal Gain		23		dB
Gctrl	Gain control Range		23		dB
OIP3	Output Intercept Point order 3 @ gain max		28		dBm
P1dB	Output power at 1dB compression @ gain max		23		dBm

ESD Protection: Electrostatic discharge sensitive device. Observe handling precautions!

*Preliminary***Electrical Characteristics**

Tamb. = 25°C, Vd = 4.5V, Gc= Gc1 = Gc2 = Gc3, CW bi asing mode.

These values are representative of onboard measurements as defined on page13.

Symbol	Parameter	Min	Typ	Max	Unit
Fop	Operating frequency range	5.5		16	GHz
G	Nominal Gain @ gain max. from 5.5 to 14GHz		23		dB
	from 14 to 16GHz		22		dB
NF	Noise Figure @ gain max.		7		dB
	Noise Figure @ gain min.		20		dB
RLin	Input Return Loss		8		dB
RLout	Output Return Loss from 5.5 to 11GHz		6		dB
	from 11 to 16GHz		8		dB
OIP3_Gmax	Output Intercept Point order 3 @ gain max. with Pout SCL [14–17]dBm		30		dBm
	Output Intercept Point order 3 @ gain max. with Pout SCL < 14dBm from 5.5 to 11GHz		28		dBm
	Output Intercept Point order 3 @ gain max. with Pout SCL < 14dBm from 11 to 16GHz		26		dBm
OIP3_Gmin	Output Intercept Point order 3 @ gain max. from 5.5 to 7GHz		26		dBm
	Output Intercept Point order 3 @ gain max. from 7 to 11GHz		22		dBm
	Output Intercept Point order 3 @ gain max. from 11 to 16GHz		18		dBm
P1dB	Output power at 1dB gain comp. @ gain max.		23		dBm
Gctrl	Gain control range from 7 to 16GHz		23		dB
Vd	Drain bias voltage		4.5		V
Id	Drain bias current (*)		220		mA
Vg	DC gate voltage		-1.3		V
Gc	DC gain control voltage	-2		+0,6	V

(\*) Id not affected by Gc.

## Absolute Maximum Ratings (1)

Tamb. = + 25°C

*Preliminary*

Symbol	Parameter	Values	Unit
Vd	Maximum Drain bias voltage	+5	V
Id	Power supply quiescent current	250	mA
Vg	Gate bias voltage	-4 to +0.8	V
Gc	DC gain control voltage	-2.5 to +0.8	V
Pin	Maximum input power overdrive	+7	dBm
Top	Operating temperature range	-40 to +80	°C
Tj	Junction temperature (2)	175	°C
Tstg	Storage temperature range	-55 to +125	°C

(1) Operation of this device above any one of these parameters may cause permanent damage.

(2) Thermal Resistance channel to ground paddle = 91.4°C/W for Tamb. = +80°C.

### DEVICE THERMAL SPECIFICATION : CHA4664-QGG

Max. junction temperature (Tj max)	:	171 °C
Max. continuous dissipated power @ Tcase= 80 °C	:	0.999 W
=> P <sub>diss</sub> derating above Tcase= 80 °C	:	11.03 mW/°C
Device thermal resistance (Rth)	:	90.64 °C/W
Min. package back side operating temperature	:	-40 °C
Max. package back side operating temperature	:	80 °C
Min. storage temperature	:	-55 °C
Max. storage temperature	:	125 °C

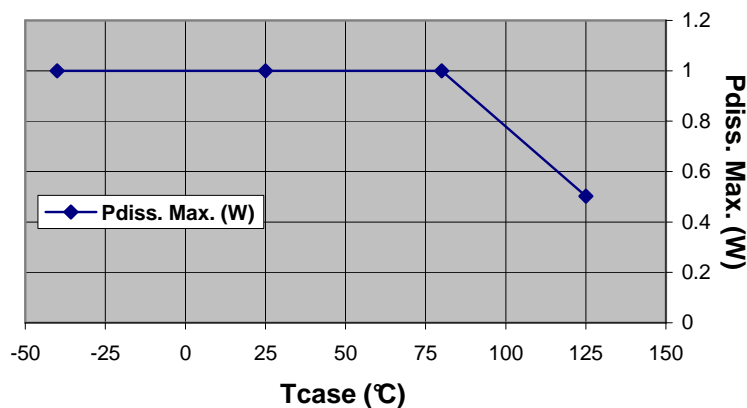

Typical Measured Performance

*Preliminary*

Tamb = + 25°C, Vd = +4.5V, Id = 220mA

Measurements in the package access planes, using the proposed land pattern & board 97364, as defined page 15.

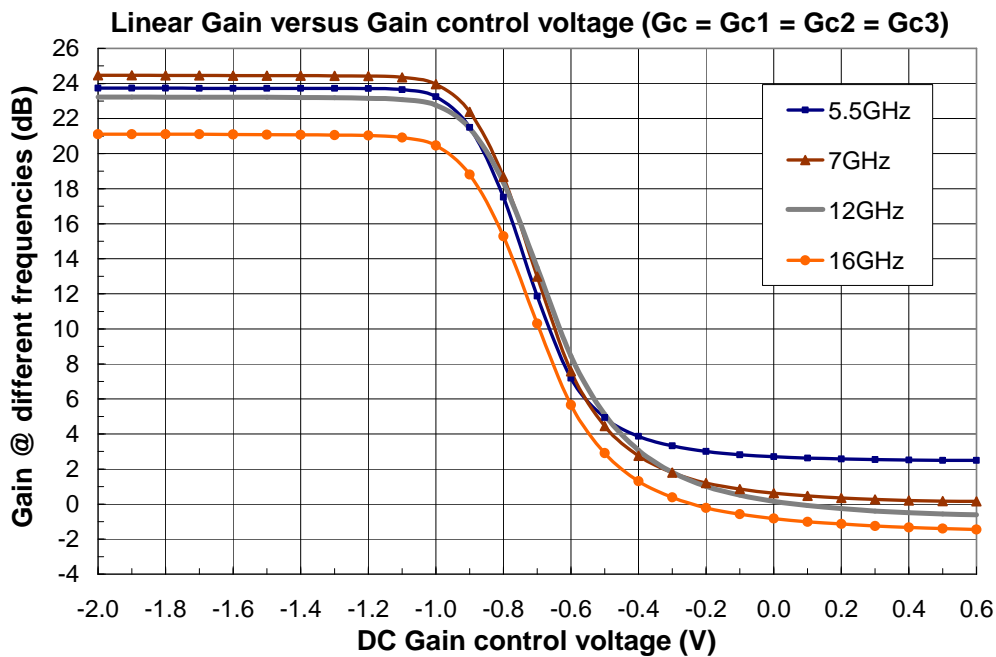
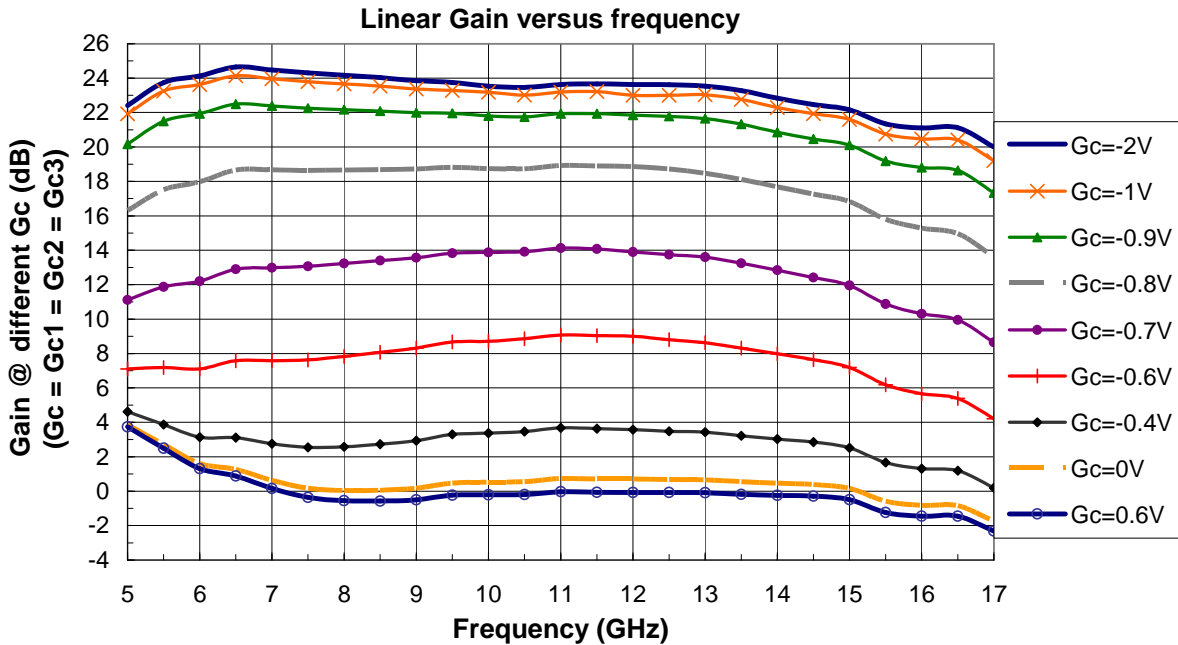

*Preliminary*

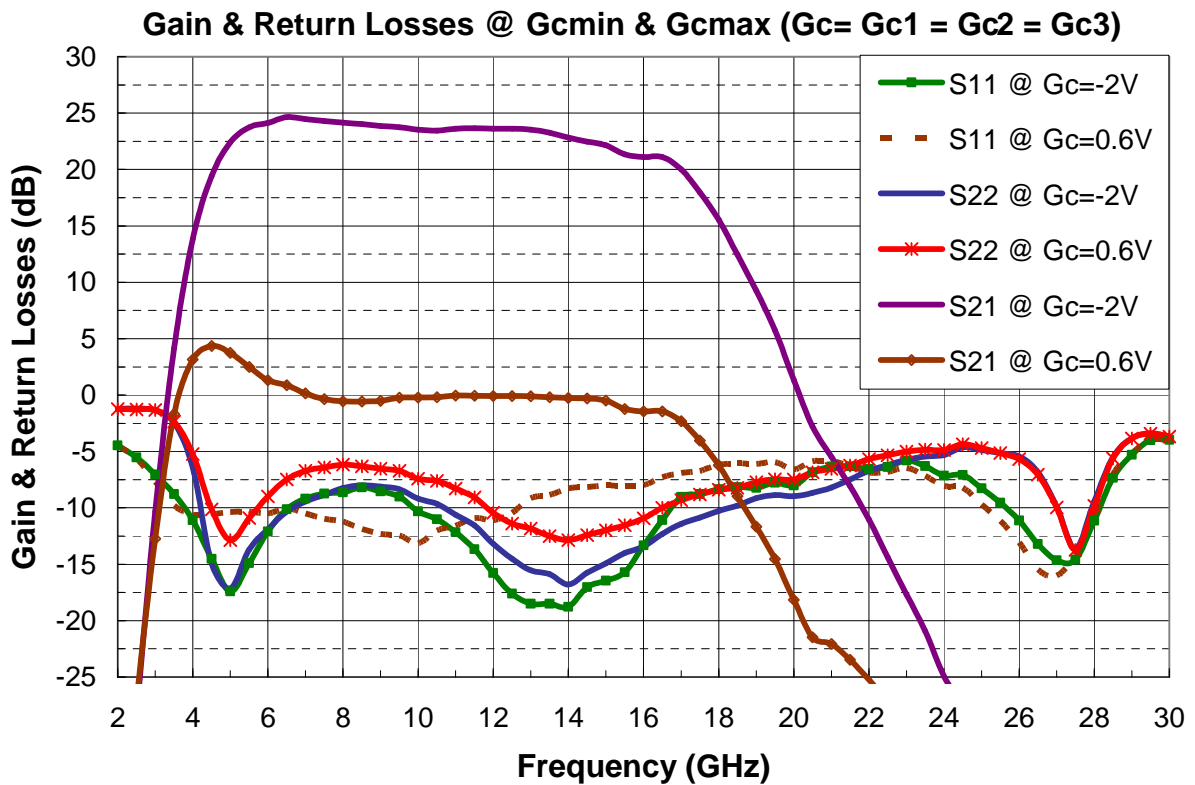
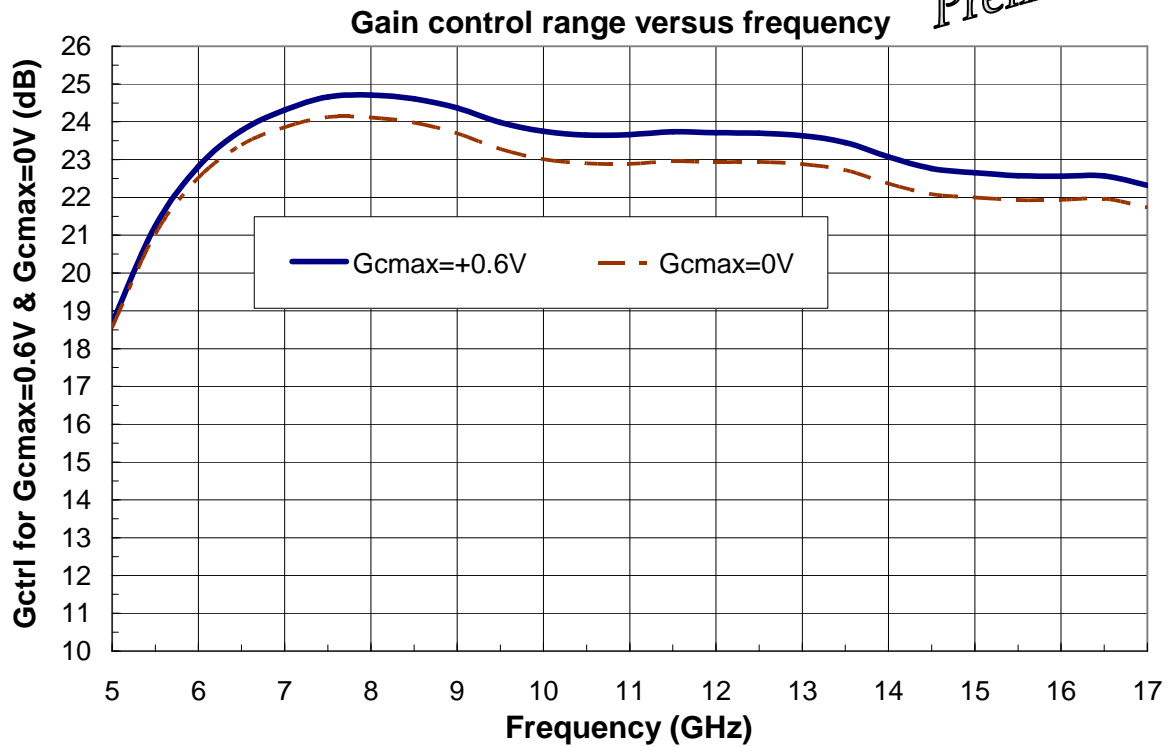

## Typical Package Sij parameters for minimum gain control voltage

Tamb = + 25°C, Vd = +4.5V, Id = 220 mA, Gc= Gc1 = G c2 = Gc3 = -2V

*Preliminary*

F (GHz)	dB(S11)	Ph(S11) (°)	dB(S12)	Ph(S12) (°)	dB(S21)	PhS21 (°)	dB(S22)	Ph(S22) (°)
2	-4.5	33	-71.6	-50	-43.4	126	-1.2	28
2.5	-5.5	-3	-64.2	-127	-28.0	162	-1.2	-13
3	-7.0	-41	-77.0	154	-10.3	147	-1.4	-54
3.5	-8.8	-80	-80.1	-41	4.2	73	-2.5	-105
4	-11.1	-125	-91.3	8	13.9	-12	-6.4	-166
4.5	-14.5	179	-76.0	107	19.4	-97	-15.0	116
5	-17.4	93	-76.4	75	22.4	-174	-17.2	-1
5.5	-14.9	9	-66.8	96	23.7	118	-13.7	-51
6	-12.1	-43	-65.0	52	24.1	57	-11.9	-78
6.5	-10.1	-78	-64.7	38	24.7	6	-10.3	-96
7	-9.2	-108	-65.2	-6	24.5	-42	-9.4	-113
7.5	-8.7	-132	-66.2	-31	24.3	-86	-8.8	-129
8	-8.6	-156	-67.3	-67	24.2	-129	-8.3	-144
8.5	-8.2	-178	-65.6	-136	24.0	-170	-8.0	-161
9	-8.5	161	-67.2	-178	23.9	151	-8.1	-179
9.5	-9.0	139	-64.0	145	23.8	112	-8.4	162
10	-10.3	117	-65.4	114	22.9	72	-9.2	143
10.5	-11.0	100	-62.7	103	23.5	38	-9.7	128
11	-12.2	79	-67.0	70	23.6	2	-10.6	113
11.5	-13.7	59	-68.1	40	23.7	-36	-11.6	96
12	-15.8	40	-75.3	59	23.2	-77	-13.2	76
12.5	-17.6	29	-78.8	78	23.2	-116	-14.5	54
13	-18.5	13	-65.8	114	23.5	-153	-15.5	32
13.5	-18.5	1	-62.9	115	23.3	168	-15.9	7
14	-18.8	-26	-60.2	120	22.8	129	-16.8	-30
14.5	-17.0	-59	-57.6	108	22.5	90	-15.8	-63
15	-16.5	-89	-54.4	103	22.2	51	-14.9	-93
15.5	-15.7	-137	-52.2	82	21.3	7	-14.0	-122
16	-13.3	-173	-50.0	54	21.1	-36	-13.4	-144
16.5	-11.1	152	-51.1	35	21.1	-80	-12.3	-160
17	-9.0	115	-51.2	21	20.0	-130	-11.4	-180
17.5	-8.8	80	-53.2	-3	18.0	-179	-10.9	164
18	-8.4	50	-54.8	1	15.5	134	-10.3	147
18.5	-8.2	29	-54.5	11	12.5	89	-9.8	127
19	-8.2	9	-53.3	10	9.3	46	-9.1	109
19.5	-7.8	-8	-53.3	0	5.7	6	-8.9	90
20	-8.0	-26	-51.3	-21	1.3	-36	-9.0	68
20.5	-6.9	-38	-50.3	-43	-2.8	-63	-8.7	53
21	-6.3	-51	-55.3	-54	-5.5	-87	-8.2	39
21.5	-6.3	-64	-58.8	-80	-8.1	-119	-7.5	21
22	-6.6	-78	-82.3	-89	-11.0	-152	-6.7	3
22.5	-6.4	-96	-56.3	52	-14.4	175	-6.2	-14
23	-5.8	-108	-50.9	31	-17.7	144	-5.8	-29
23.5	-6.3	-121	-50.4	8	-20.9	113	-5.4	-44
24	-7.1	-139	-51.1	-11	-24.9	81	-5.3	-62
24.5	-7.1	-146	-48.2	5	-27.5	52	-4.6	-76
25	-8.3	-157	-48.0	-20	-29.9	23	-4.9	-91
25.5	-9.5	-170	-48.1	-26	-33.5	-6	-5.1	-108
26	-11.1	180	-46.8	-34	-37.0	-19	-5.4	-123
26.5	-13.2	177	-46.0	-31	-36.6	-30	-6.8	-138
27	-14.6	-166	-46.9	-43	-37.8	-49	-9.9	-146
27.5	-14.6	-140	-42.6	-46	-38.0	-73	-13.6	-130
28	-11.1	-134	-43.4	-63	-40.9	-95	-9.4	-106
28.5	-7.3	-135	-42.1	-73	-44.7	-87	-5.5	-116
29	-5.3	-147	-40.4	-81	-41.3	-85	-3.8	-138
29.5	-4.0	-167	-42.3	-115	-44.0	-125	-3.4	-155
30	-4.0	175	-44.4	-120	-46.8	-113	-3.7	-179

Refer to the "definition of the Sij reference planes" section below.

## Typical Measured Performance:

Tamb = + 25°C, Vd = +4.5V, Id = 220mA

*Preliminary*

Measurements in the plan of the connectors, using the proposed land pattern & board 97364, as defined page 15.

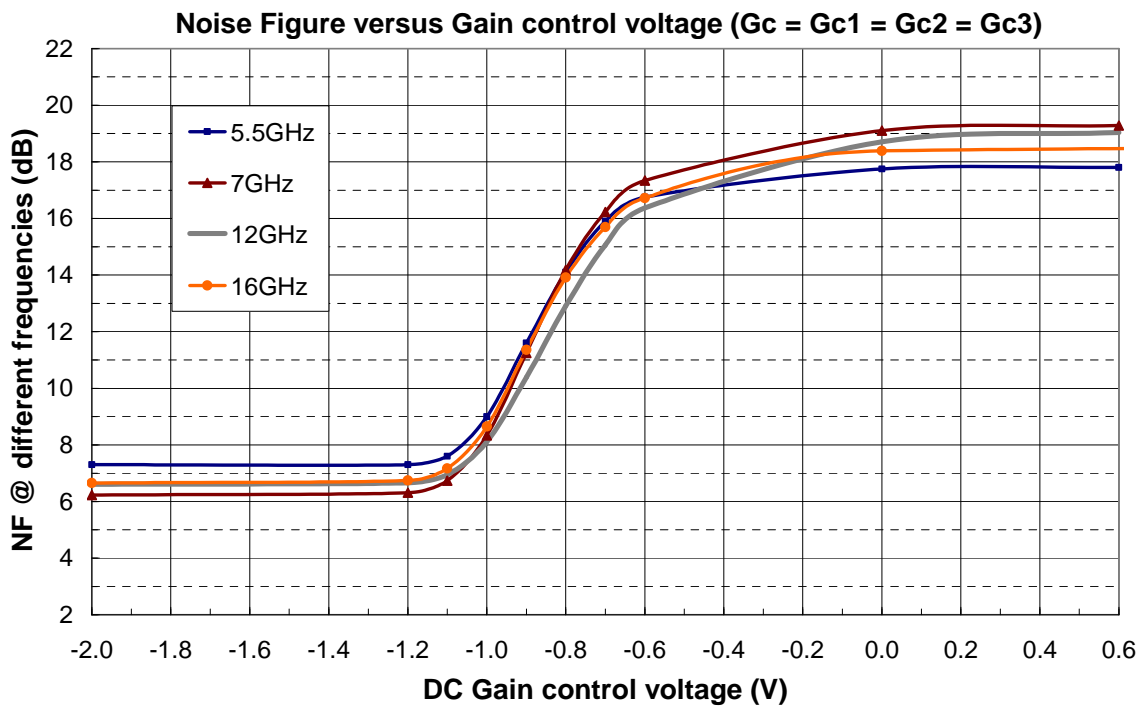
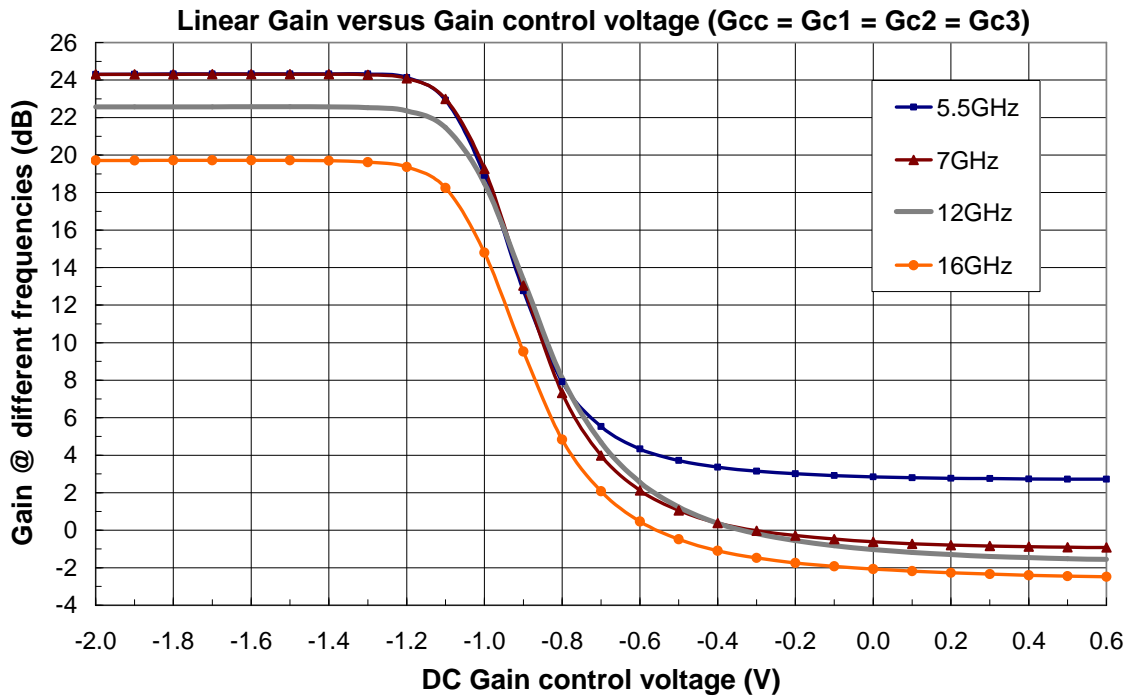

*Preliminary*

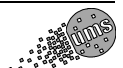
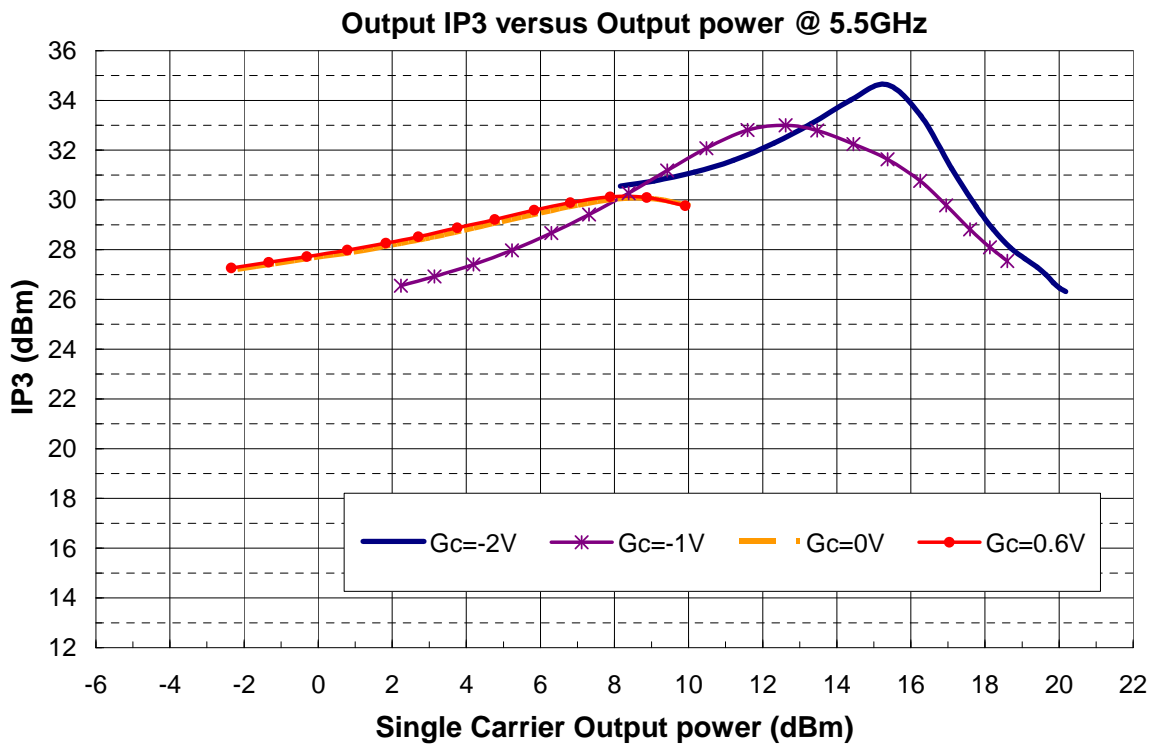
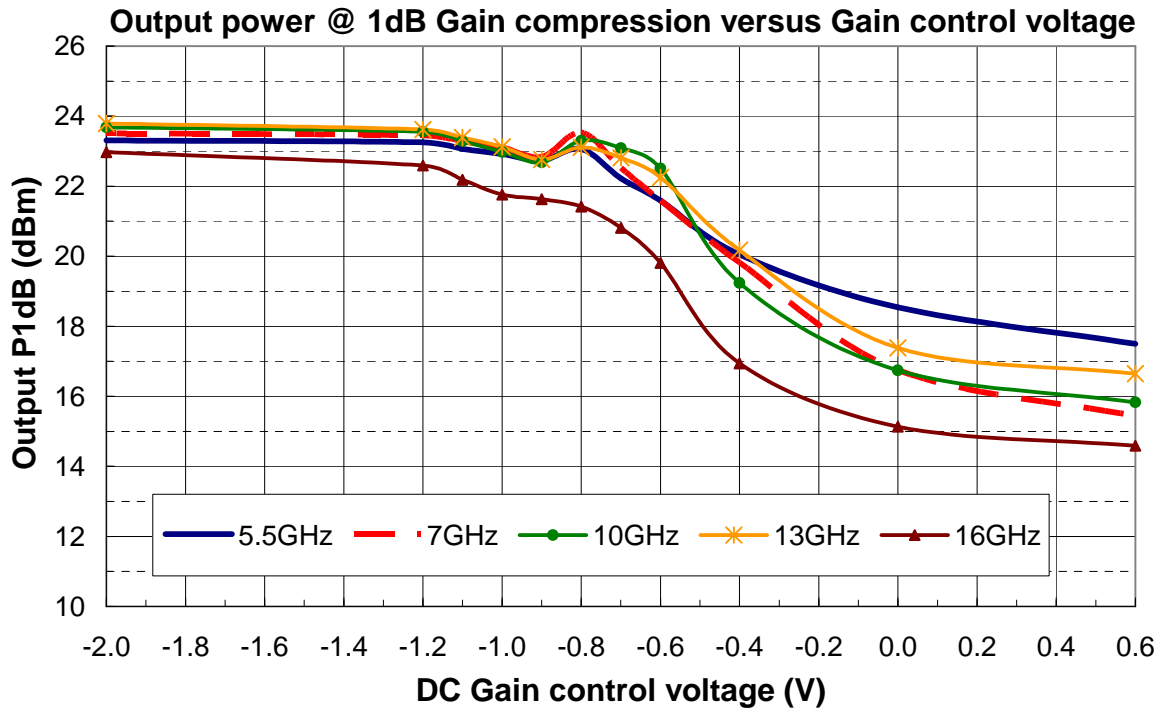



*Preliminary*

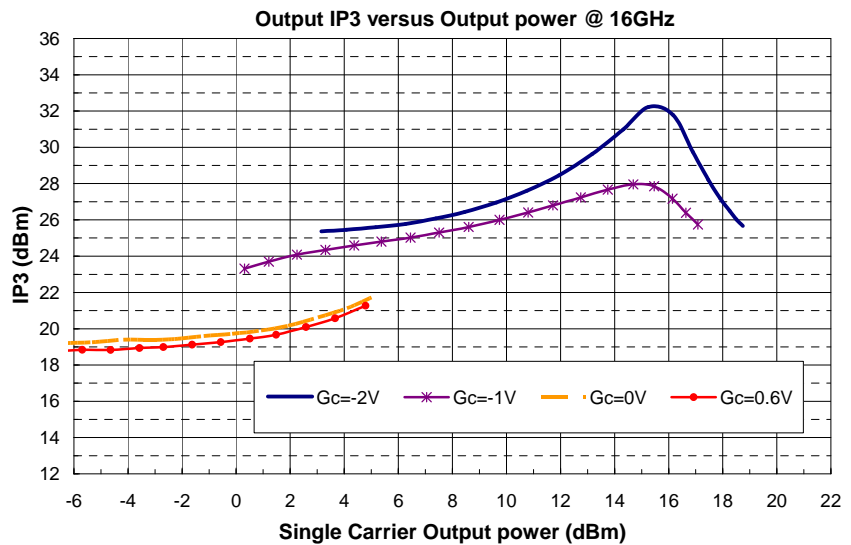
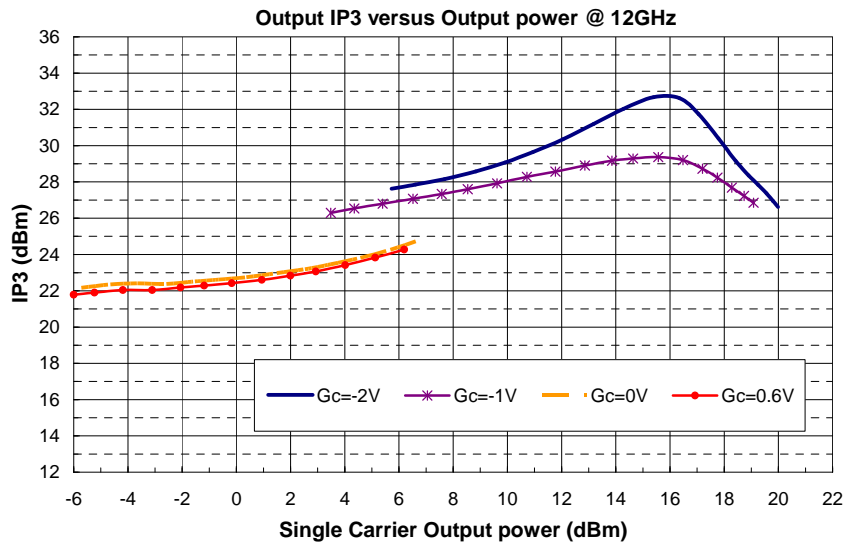
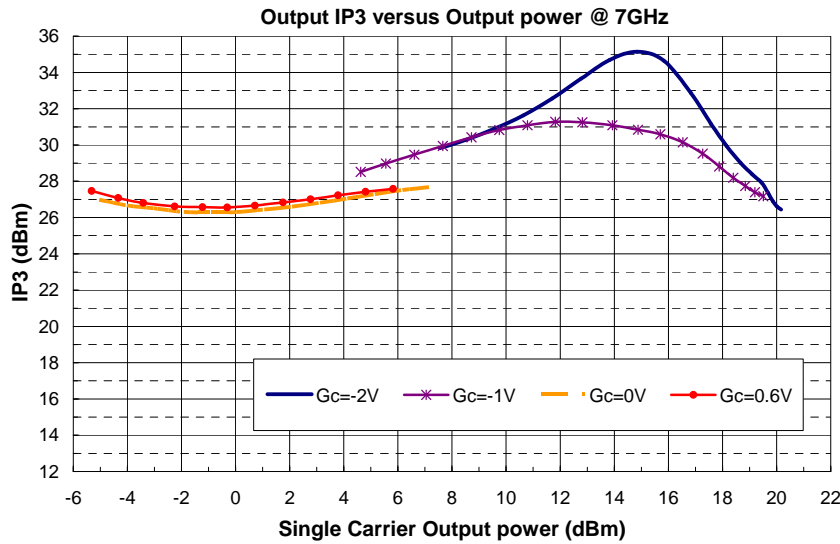

Typical Measured Performance in Temperature:

*Preliminary*

T = -40°C, +25°C & +75°C, Vd = +4.5V, Id = 220mA @ Tamb

Measurements in the plan of the connectors, using the proposed land pattern & board 97364, as defined page 15.

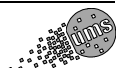
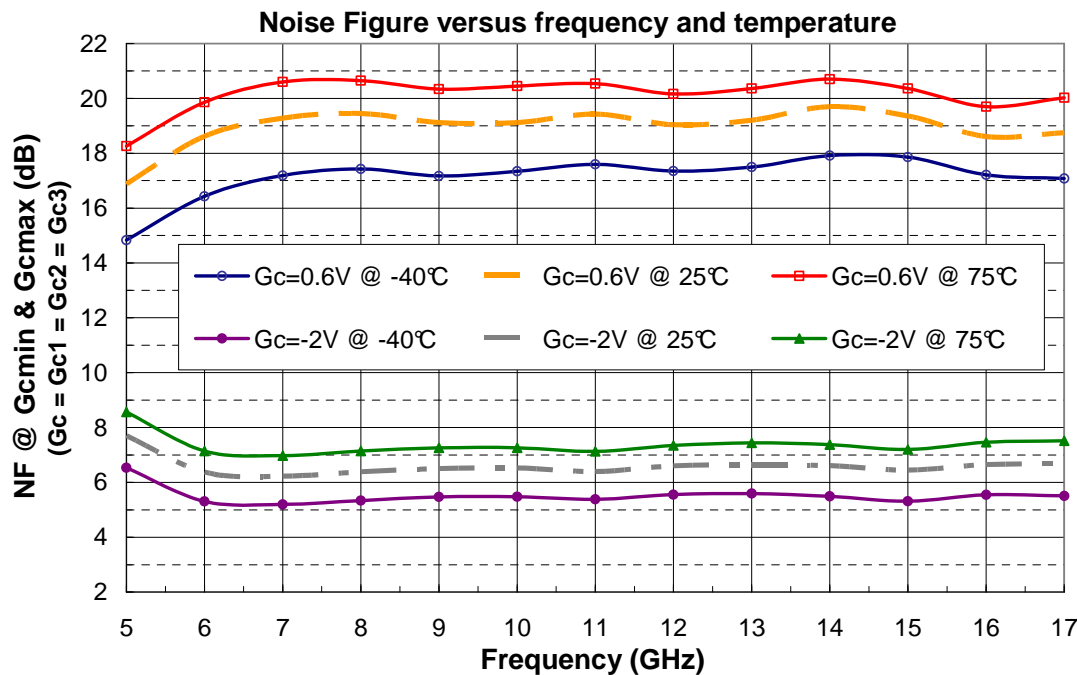
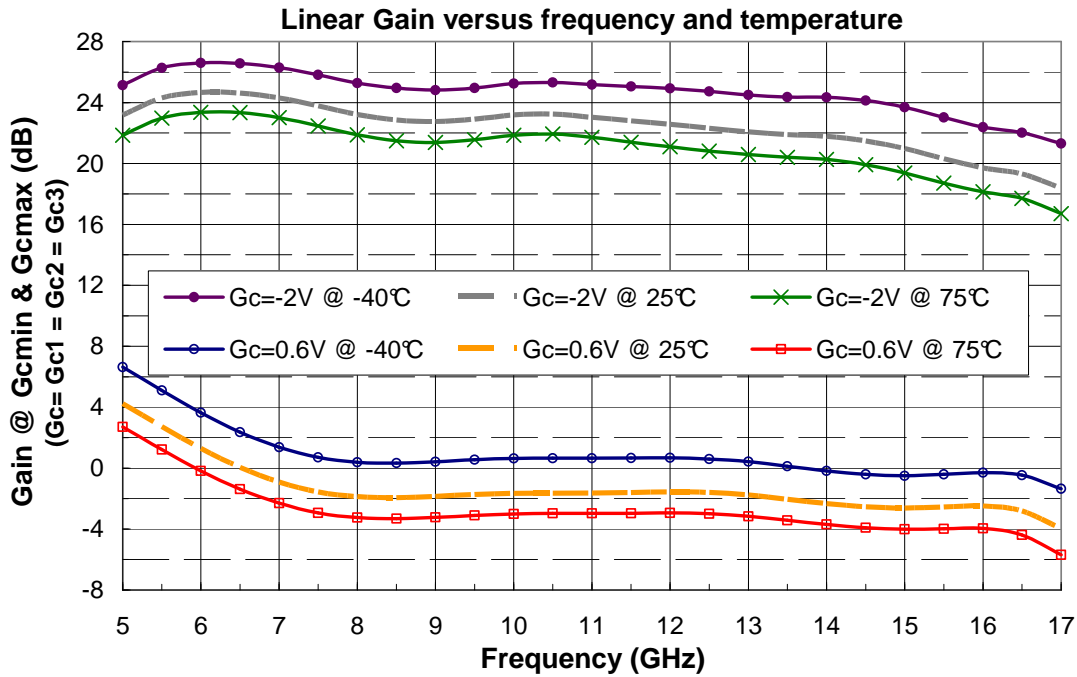

*Preliminary*

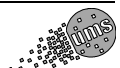
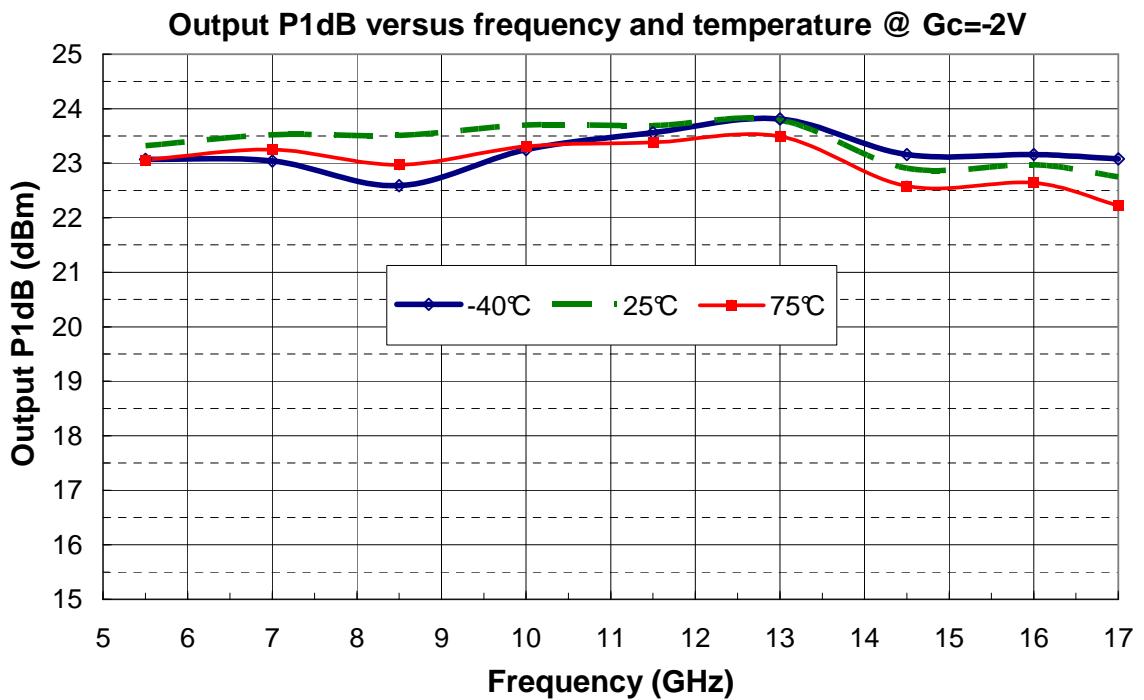
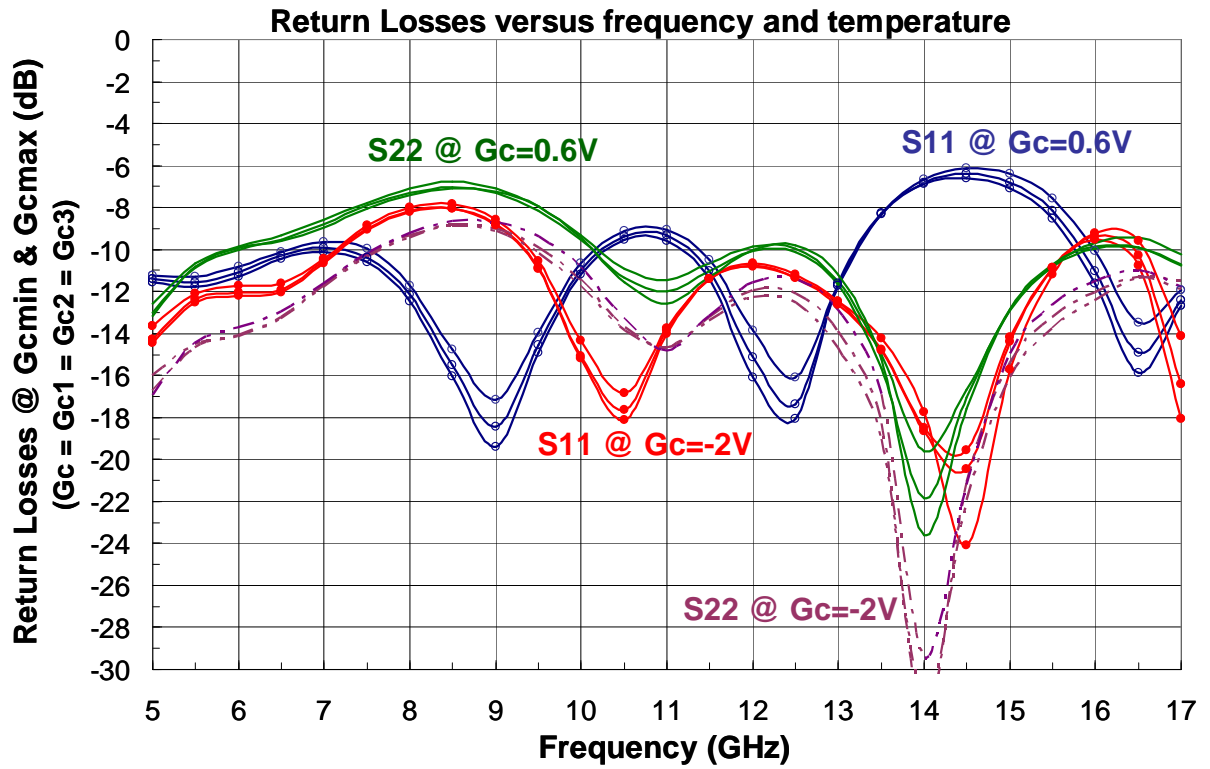

Package outline:

*Preliminary*

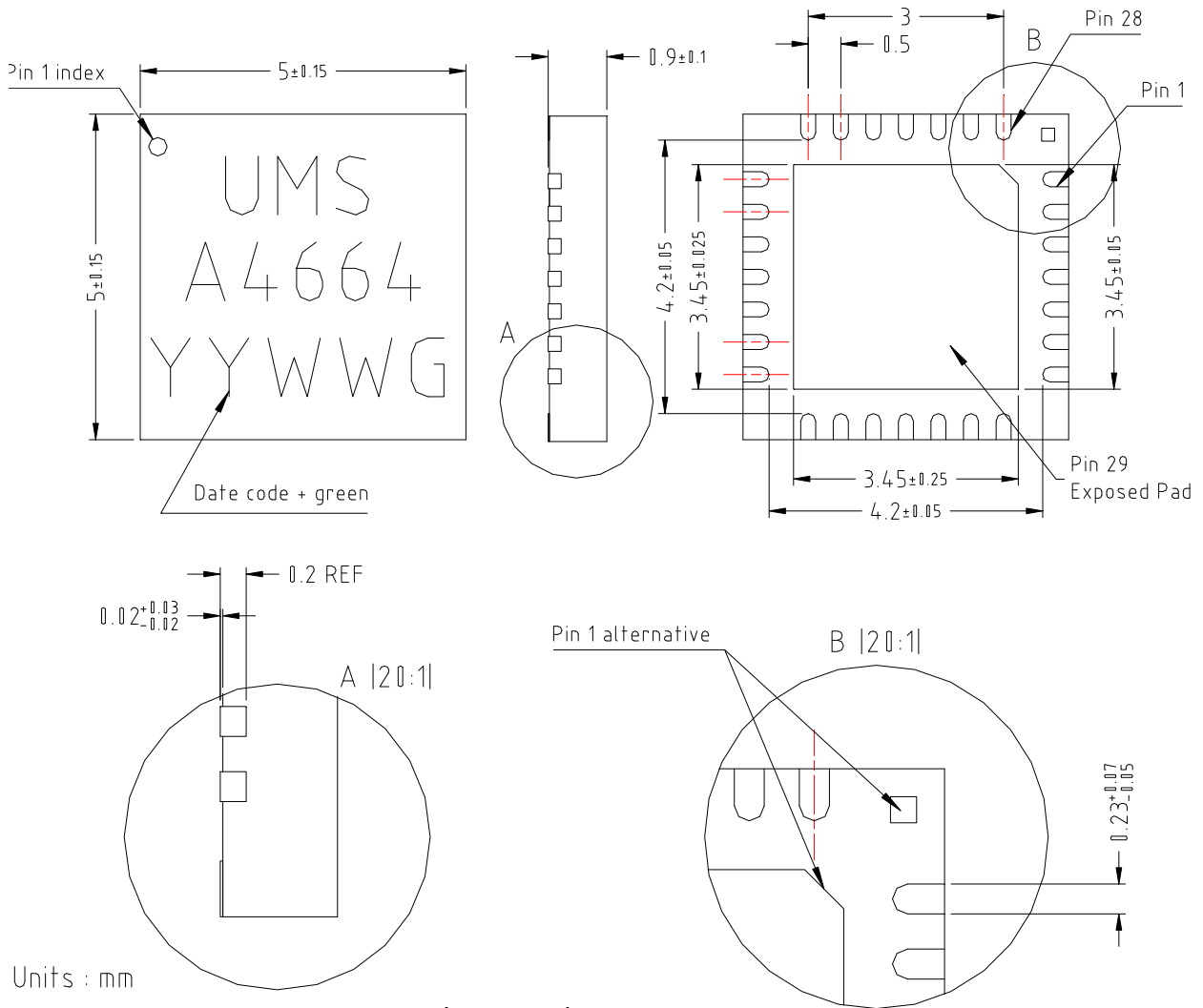

Units : mm

From the standard : JEDEC MO-220 [ VHHD-3 ]

Matt tin, Lead free [Green]

1- Gnd	10- Vg12	19- Gnd	28- Nc
2- RF IN	11- Gc2	20- RF OUT	29- GND Exposed Pad
3- Gnd	12- Vg3	21- Gnd	
4- Gnd	13- Gc3	22- Nc	
5- Nc	14- Nc	23- Nc	
6- Gnd	15- Gnd	24- Vd	
7- Gnd	16- Gnd	25- Nc	
8- Nc	17- Nc	26- Nc	
9- Gc1	18- Gnd	27- Nc	

## Recommended footprint for 28L QFN5x5

*Preliminary*

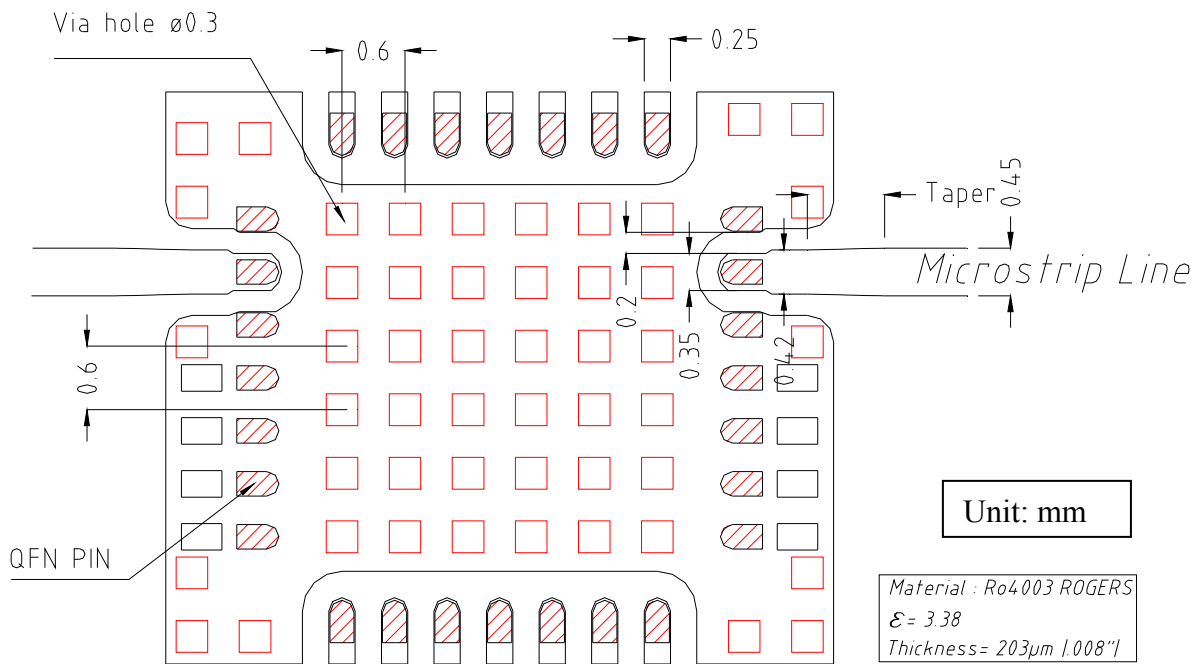

## Definition of the Sij reference planes

The reference planes are defined from the footprint of the recommended characterization board shown to the right.

The reference is the symmetrical axis of the package. The input and output reference planes are located at 3.66mm offset (input wise and output wise respectively) from this axis. Then, the given Sij incorporates this land pattern.

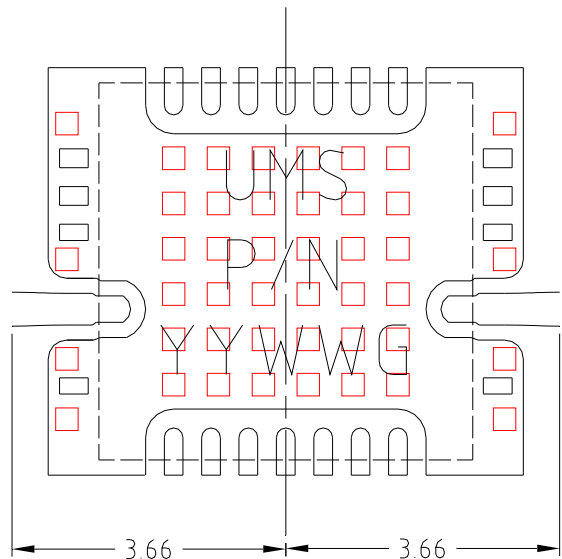

*Preliminary***SMD mounting procedure**

The SMD leadless package has been designed for high volume surface mount PCB assembly process. The dimensions and footprint required for the PCB (motherboard) are given in the drawing above.

For the mounting process standard techniques involving solder paste and a suitable reflow process can be used. For further details, see application note AN0017.

**Note**

Due to ESD protection circuits on RF input and output, an external capacitance might be requested to isolate the product from external voltage that could be present on the RF accesses.

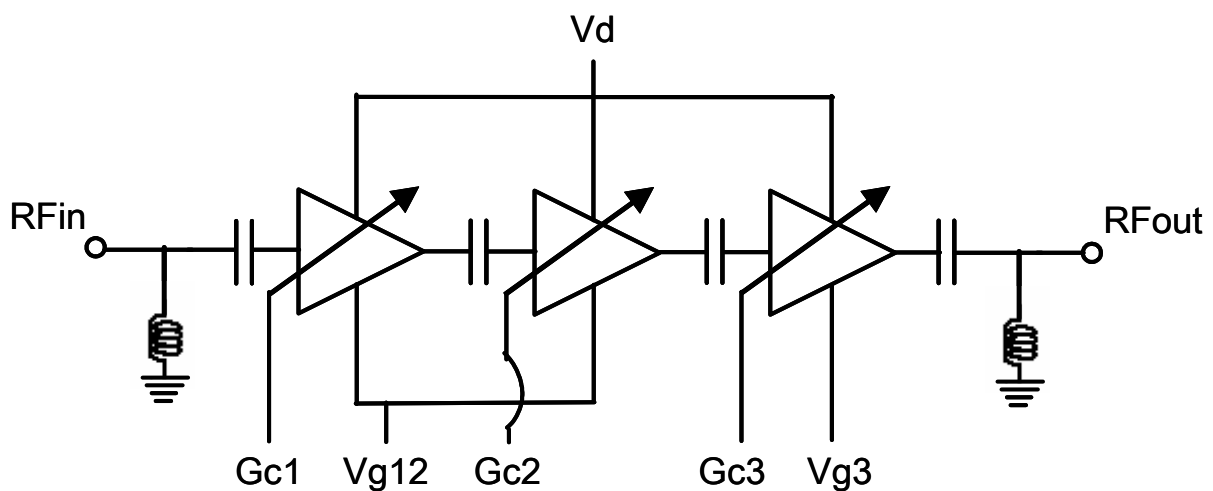

ESD protections are also implemented on gate accesses.

The DC connections do not include any decoupling capacitor in package, therefore it is mandatory to provide a good external DC decoupling on the PC board, as close as possible to the package.



*Preliminary*

## Ordering Information

QFN 5x5 RoHS compliant package: CHA4664-QGG/XY  
Stick: XY = 20      Tape & reel: XY = 21

Information furnished is believed to be accurate and reliable. However **United Monolithic Semiconductors S.A.S.** assumes no responsibility for the consequences of use of such information nor for any infringement of patents or other rights of third parties which may result from its use. No license is granted by implication or otherwise under any patent or patent rights of **United Monolithic Semiconductors S.A.S.** Specifications mentioned in this publication are subject to change without notice. This publication supersedes and replaces all information previously supplied. **United Monolithic Semiconductors S.A.S.** products are not authorised for use as critical components in life support devices or systems without express written approval from **United Monolithic Semiconductors S.A.S.**

